

PHILP of FALKIRK LTD.  
INDUSTRIAL STORAGE  
VICTORIA ROAD, FALKIRK  
Tel. 0324 24693/4

244









# Some things go on getting better and better

Since their introduction, the Volvo 240 saloons have established themselves as leaders in the executive car market. The reason for their success is Volvo's unique and world-famous combination of quality, reliability, durability and safety, coupled with high-standard specifications and exceptional value for money.

The Volvo virtues have always been coveted by the discerning individual, and in today's uncertain environment they provide you with a constant reminder that you have made the right choice of car.

The 1980 244 range again reflects Volvo's unrelenting commitment to provide the discerning motorist with a standard of quality and reliability which is now legendary in the motor industry. Standard specifications have been raised: there is new upholstery, interior adjustable door mirrors, and facilities provided to make in-car entertainment installation easier.

One area in which Volvo has sometimes been underrated is handling and road-holding. In this brochure you will find more information about these features. Volvo's engineers working in the Technical Centre have spent millions of pounds on research and development to improve their already superior standards of steering, suspension and braking. It is one thing to describe these features but another to experience them. The only way to do this is to test-drive the 1980 models to see how much better great things can become.

# The 240 series

There are three models in the 1980 240 saloon car range; the 244DL, 244GL and 244GLE. The standard equipment checklist at the back of this brochure will show you the famous luxury specifications of the 244DL and the extra specifications offered by the 244GL and GLE. The 244GLE also has the extra power, fuel economy, and the controlled response of fuel injection.

The Volvo 240 series includes a range of prestigious estate cars which are described in a separate brochure - Volvo 245/265:

Your local Volvo Dealer will be happy to arrange a test-drive for you. You'll find his name and address in Yellow Pages, or ring (0494) 33444.





# The driving seat

Sitting in the famous driving seat (which incidentally is electrically heated), you will immediately notice the impressive array of instruments and controls. The comprehensive range, their careful layout and easy access all provide for instant recognition and finger-tip control. All the controls you would expect to find are there, but there may be some you might not even have thought of.

On the instrument panel in front of you are the speedometer (in mph and kph), rev counter, fuel gauge, temperature gauge and warning lights for exterior bulb failure, brake circuit failure, handbrake application, alternator charge, oil pressure, and main beam.

To the right is the light switch. Remember, too, that day-running lights are fitted as standard and go off only when you turn off the ignition or when you put parking or headlights on. If you leave your lights on or your keys in the ignition, a warning buzzer will give you a sharp reminder as you open the driver's door to get out.

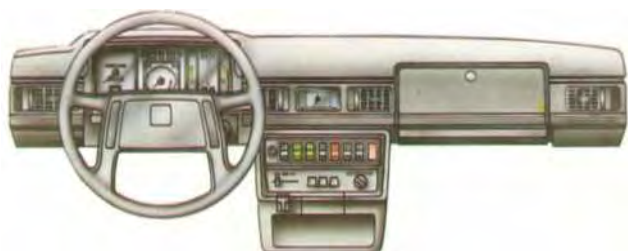

Also in the dashboard is a Volvo quartz clock. Below it on the centre console is the rheostat to control the level of dashboard lighting, and switches for the electrically heated rear window, hazard warning lights, and rear foglights. Also situated here are the controls for Volvo's famous heating and ventilation system, cigar lighter, ashtray and 'FASTEN SEAT BELTS' reminder.

The glove box on the left of the dashboard is lockable, illuminated and incorporates a folding vanity mirror.

The powerful horn is operated by the two sensors on the steering wheel hub. The controls for the windscreen wipers/washer, headlight wipers/washer, main beam and the indicators are on the steering column.

*The radio/stereo player illustrated is a genuine Volvo accessory.*











# Traditional Volvo comfort

Volvo cars are built to provide maximum comfort for an individual driver or a whole family. The driver's seat is the result of extensive research by Volvo designers and orthopaedic specialists. The backrest is infinitely adjustable down to a fully reclined position. It has a unique lumbar support for the small of your back. The seat cushion and backrest are electrically heated; the element switches on automatically at temperatures below 14°C. The seat can also be raised or lowered by levers not only to give a better driving position, but also to improve your all-round visibility. Rear-seat passengers, too, sit in comfort: the seats are well shaped, have a centre armrest and seat belts as standard; the leg room is exceptionally good.

For improved comfort and safety, the new door mirror is adjustable from inside the car. 1980 models boast new upholstery colours and an even higher degree of colour co-ordination.



*The Volvo seat has an extremely wide range of adjustment to allow the driver to choose an individual position.*



*The boot is illuminated and provides 21.5 cu. ft. of space. The boot panel is low to allow easy loading. Most suitcases can stand "handle up."*

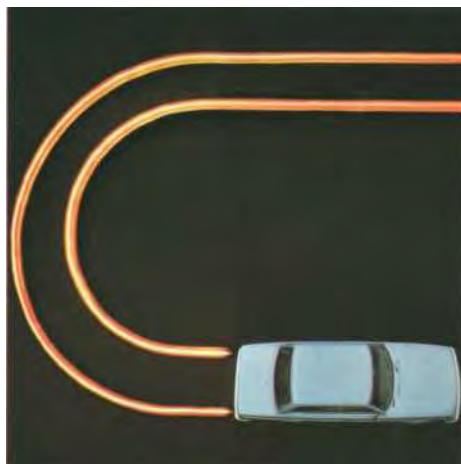

*The turning circle is amazingly small, 32' 2", just as small as a VW Golf.*

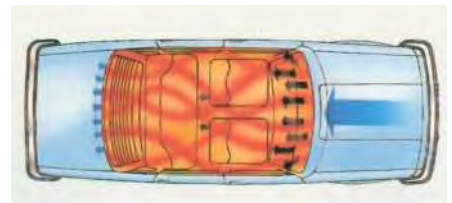

*The extremely efficient heating and ventilation system distributes warm or cool air evenly through 14 air vents. The comprehensive controls allow you to select the optimal settings for heat, demist or fresh air and to direct it precisely to where it is required.*



# Volvo's exceptional handling and roadholding

Volvo is world famous for injury preventive safety which helps minimise injury if you are unfortunate enough to be involved in an accident. But Volvo also helps you to avoid accidents: this we call accident preventive safety. The main properties contributing towards accident preventive safety are acceleration, braking, steering and road-holding. These, when optimally balanced, give the car predictability. When a person is suddenly faced with difficult situations that call for fast and accurate reaction from both driver and car, a Volvo reacts in the manner you expect it to.

This is not as obvious as it may seem. Many cars develop sudden tendencies to over or under steer when cornering too hard; rear wheels may lock when braking hard in an emergency, resulting in the rear end of the car going into an unexpected skid. This is unlikely to happen in a Volvo.

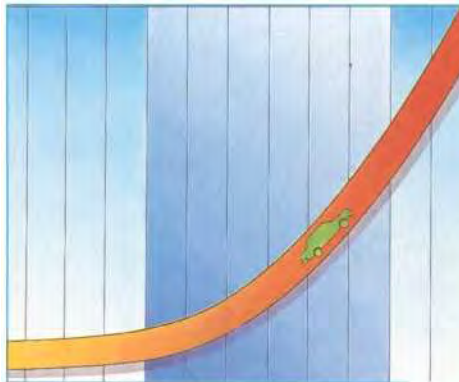

## ACCELERATION

In today's society it is not so important to be the first away from the traffic lights. But it is important to ensure you have economical power when you really need it: when overtaking, i.e. in the 25-60 mph range. And this is where the Volvo excels.

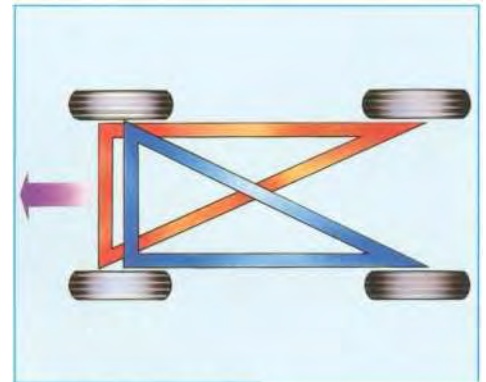

## BRAKING

Straight-line braking adds to the predictability of your car in difficult situations. Furthermore, Volvo's unique dual-circuit triangle-split braking system, including the stepped-bore master cylinder,

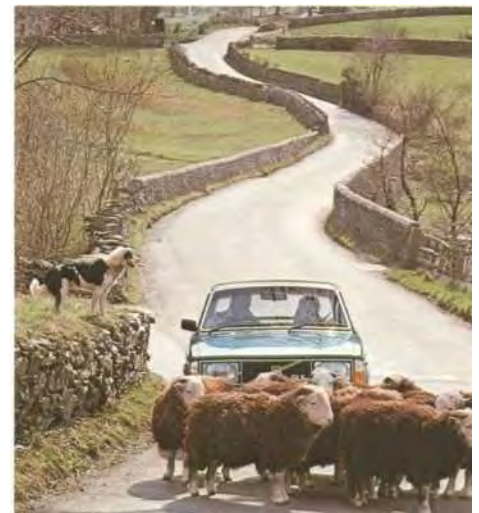

means that if one circuit should fail, both front brakes and one rear brake will operate, giving 80% braking effect with maximum directional stability. The brake pedal feels and works almost normally and so does not cause the driver to panic.

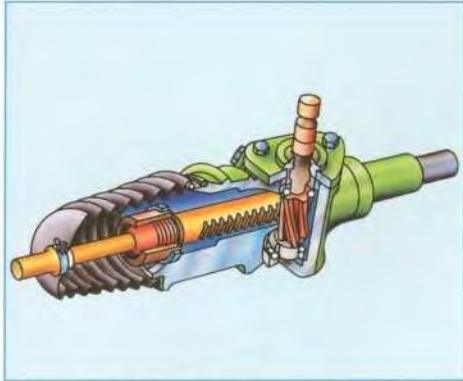

## STEERING

Volvo's rack and pinion steering gives a light and precise steering response with carefully balanced time-lag between steering wheel movement and wheel movement, which makes the car respond in the way the average motorist expects.

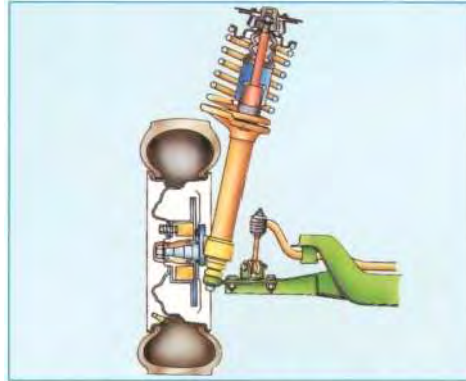

## ROADHOLDING

The Volvo 244 has spring strut front suspension - a common design on modern cars because of its compactness. The spring strut consists of a shock absorber in a protected tube surrounded by a coil spring. The rear suspension of a Volvo has a live rear axle. The movement of the rear axle is controlled by two support arms, two torque rods which limit axle wind-up during acceleration

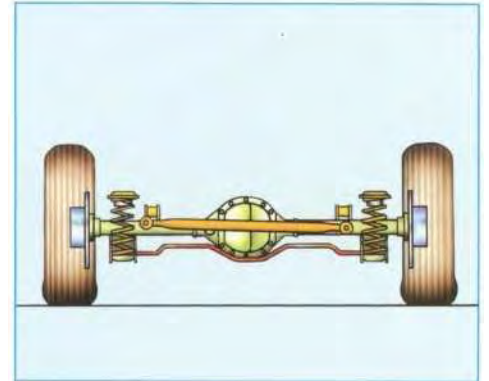

and braking, and a track rod which holds the axle laterally. Coil springs, a stabilizer and shock absorbers complete the picture. Combined together, this arrangement gives the feel of the road to the driver, holds the road exceptionally well and keeps both driver and passengers comfortable.









# The safest place on the road

Whilst the accident preventive safety attributes of Volvo may not be fully appreciated, the injury preventive safe features of Volvo are legendary. It is a comforting thought that, should anything happen, you and your family are probably safer in your Volvo than in any other make of car.

For many years, Volvo has pioneered research resulting in safety features that are today compulsory requirements in many countries - 3 point seat belts, laminated windscreen, integral head restraints. For many years Volvo has had bumpers which absorb 5 km/h crashes without damage to the body and has pioneered front and rear crumple zones as well as side impact protection.

Recent surveys in Sweden showed Volvo drivers were involved in 61% fewer fatal accidents than the number of cars on the road would lead you to expect.



*Safety crumple zones front and rear. The driver and passengers are protected by the famous Volvo safety cage with its strong steel profiles. The doors are also strengthened with strong tubular steel bars to protect against side impact.*



*Steering wheel and steering column are designed for maximum safety in the event of a collision:*

- 1) The lower steering shaft gives way.*
- 2) The steering shaft telescopes.*
- 3) The steering column slides forward and downward.*
- 4) The steering wheel attachment gives way.*
- 5) The padded area over the centre of the steering wheel provides further protection.*

# The highest standards

A car is worth very little if it does not function properly. Reliability is one of the exceptional qualities of the Volvo 244 and never more important than in the 1980's. It will function properly even in severe climates, under hard stress and will continue to do so for many years.

Volvo ensure reliability in several ways:

- well-proven design
- high quality materials and components
- advanced manufacturing methods
- thorough quality control throughout the production process.

In addition, efficient service routines have been carefully developed and full service facilities, as well as parts, are readily available at over 240 Volvo Dealers in the U.K.

Components that go into the 244 today have been tried and proven for many years. However, improvements are made each year. New or redesigned components are all subject to Volvo's on-going testing procedures before being included in production cars.

One of the most critical aspects is Volvo's unique system of specification standards. Before construction of a new component system or an entirely new car is started, specification standards are decided upon for every item. Volvo requires the same high-quality standards from its suppliers and makes frequent checks to ensure that quality requirements are never allowed to deteriorate. Volvo

purchase many of their components in the U.K. and are the largest single export customer for U.K. automotive parts. By the end of 1979 Volvo will have purchased £90 million worth from over 300 British companies during the year.

It goes without saying that it takes extremely sophisticated manufacturing and control methods to keep track of all components and ensure they are put together in the proper way - so that the end result will be the quality Volvo that people know and expect. The degree of automation throughout the entire process is considerable, e.g. automatic welding machines and some 50 robots are responsible for 97% of the welding. This ensures a very high and consistent quality, and is representative of the standards throughout the entire assembly plant.



*The Volvo 240 series has a four-cylinder, water-cooled engine with five-bearing crankshaft, overhead cam-shaft and light-alloy cylinder head; an exceptionally reliable and economical unit with excellent low-speed pulling and torque characteristics especially beneficial when towing.*



*Four-speed, fully synchronised gearbox. The 244GL and GLE are fitted with over-drive which can improve fuel consumption by approximately 10%. Automatic transmission is also available on the whole 244 range.*



*Brake pipes are made of special corrosion-resistant copper/nickel alloy - a unique Volvo feature.*



# The 1980 Volvo offers you outstanding value for money

In protecting you and your passengers Volvo also protect your investment. The Volvo paint and protection process is unique. After a 5 stage painting process rust proofing agents are applied to many parts of the car - not only to the underbody, but also inside body members and other cavities. Door sills are ventilated. Special zincrometal is used for front wings, bonnet and boot lid, and zinc coated sheet metal used for other exposed, vulnerable parts of the body. In short, everything possible is done to ensure that the cars last long and function well. Official studies in Sweden show that a Volvo has an average calculated life expectancy of 17.5 years. That is 2 years more than its closest competitor, and more than 6 years longer than some other internationally acclaimed makes.



*First stage of the extensive body treatment, electrolytic primer bath.*



*Slipstream air ventilates door sills to prevent moisture and corrosion.*



*Generous use of highly corrosion-resistant double-sided hot zinc plate (zinc layer 3-4 times the thickness of most other car makes).*



*Polypropylene inner liners for front wheel housings protect against dirt and moisture as well as flying stones and gravel.*



*Vulnerable parts of the exhaust system have a rustproofing aluminium finish.*





244

GLE

244



## THE 244GL *(left of picture)*

2.1 litre, 4-cylinder carburettor engine developing 107 h (DIN).

The specification is for the individual who demands something extra in luxury. Standard are sunroof, metallic paint, tinted glass, ribbed plush upholstery, rectangular halogen headlights with wipers/washers, and overdrive on 4th gear which helps to improve fuel consumption.

## THE 244GLE *(right of picture)*

This is the top of the 244 range and has the higher performance B21E engine with fuel injection which develops 123 hp (DIN). The GLE displays all the traditional Volvo virtues, but is distinguished by its special badging. Electrically operated windows on front doors.

## THE 244DL *(overleaf)*

The DL model has the B21A carburettor engine. Its specification includes headlight washers/wipers, tachometer, day-running lights, boot light, engine bay light, integral rear fog lights, heated driving seat, interior adjustable door mirror.

## LIQUEFIED PETROLEUM GAS

The Volvo 244DL and 244GL are available with an alternative fuel system utilising liquefied petroleum gas (LPG) as well as petrol.

Volvo was a pioneer in the use of LPG to propel cars and today over 10,000 Volvos have been modified to run on this fuel. LPG not only offers savings in fuel costs (assuming no change in U.K. fuel tax legislation) but also cleaner exhaust emissions, and the security provided by two sources of energy.

The conversion can normally be carried out in one day and does not effect Volvo's new car warranty. The tank fits neatly into the boot of the 244 without causing obstruction; the petrol tank is retained and the driver can change from one fuel to another at the flick of a switch. Your local Volvo Dealer can provide full information.





# The big Volvo Estate cars

This brochure would not be complete without a brief introduction to the world-famous Volvo 240 Estate Cars, the market leaders in their class. They are not modified

saloons but purpose-built five-door estate cars which is why a separate brochure is available explaining the benefits they offer.

The 1980 245 range has three models, the 245DL, the new 245GL and the 245GLE. Performance and specifications are itemised in the 245/265 brochure:

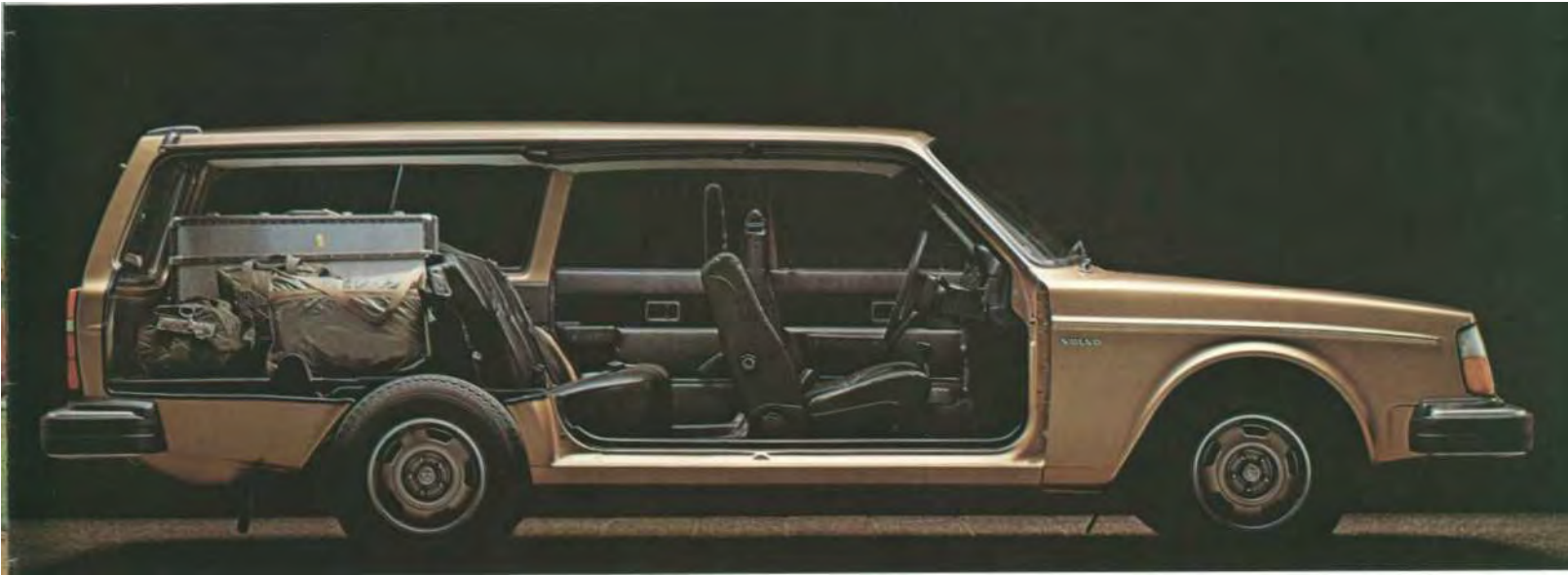

*Room for five adults and luggage with the rear seat up.*

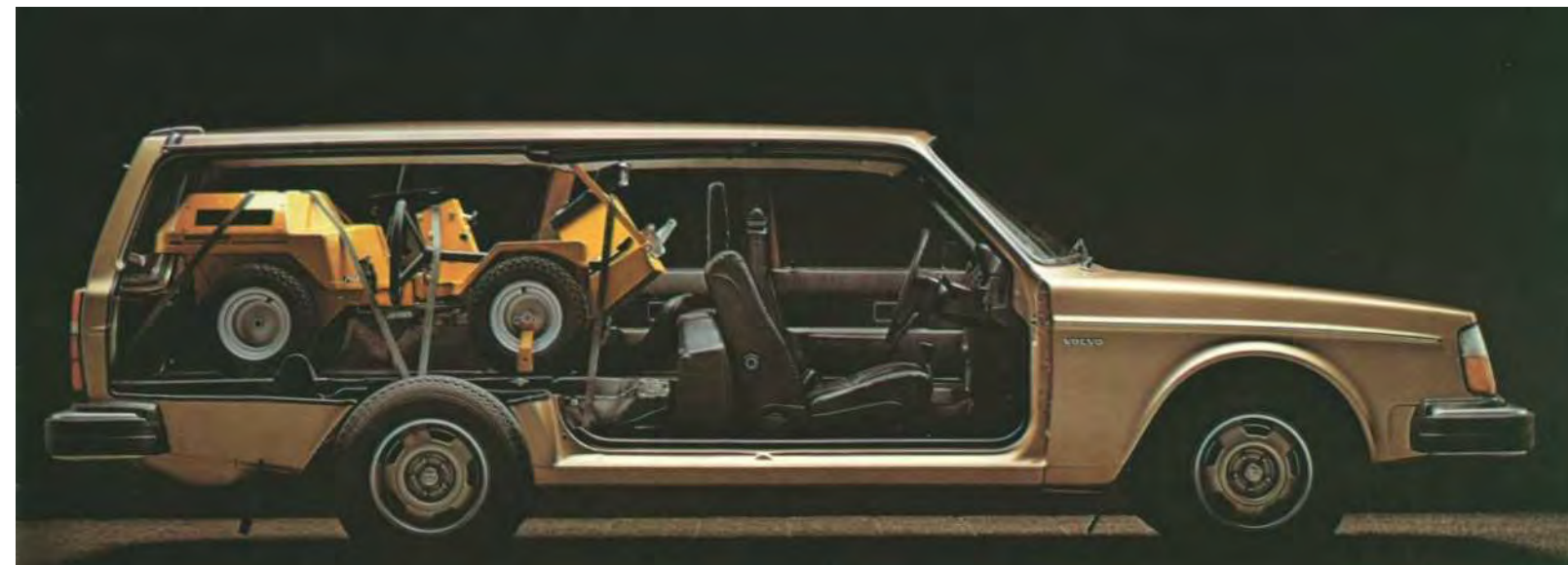

*Over 70 cu. ft. of space with the rear seat down.*

# Standard equipment

	244 DL	244 GL	244 GLE
Front seats with adjustable lumbar support	●	●	●
Electrically heated rear window	●	●	●
Head restraints, front	●	●	●
Vertical adjustment of driving seat	●	●	●
Power assisted brakes	●	●	●
Disc brakes all round	●	●	●
Bulb integrity sensor (showing if a bulb has failed)	●	●	●
Warning lamp for brake circuit failure	●	●	●
Reminder lamp for front seat belts	●	●	●
Illuminated ash tray for rear seat	●	●	●
Ignition/lights buzzer warning	●	●	●
Quartz clock	●	●	●
Halogen headlights	●	●	●
Day-running lights	●	●	●
Automatic reversing lights	●	●	●
Inertia reel seat belts front and rear	●	●	●
Child-proof rear door latches	●	●	●
Fuel tank with safety location	●	●	●
Stepped bore brake master cylinder	●	●	●
Radial ply, steel belted tyres	●	●	●
Storage recesses in doors	●	●	●
Intermittent windscreen wipers	●	●	●
Headlamp wiper/washers	●	●	●
Collapsible steering system	●	●	●
Rheostat controlled instrument lighting	●	●	●
Laminated windscreen	●	●	●
Trip-meter	●	●	●
Hazard warning lights	●	●	●
Vanity mirror	●	●	●
Cigar lighter	●	●	●
Mud flaps	●	●	●
Full carpeting	●	●	●
Day/night rear view mirror	●	●	●
Boot/luggage compartment lighting	●	●	●
Engine bay light	●	●	●
Driver's door mirror	●	●	●
Energy absorbing bumpers	●	●	●
12 month unlimited mileage warranty	●	●	●
Side impact protection	●	●	●
Tachometer	●	●	●
Rear foglights	●	●	●
Tinted glass		●	●
Metallic paint		●	●
Overdrive (on manual gearbox)		●	●
Leather upholstery		●	●
Fuel injection			●
Interior adjustable door mirror	●	●	●
Cloth upholstery	●		
Leather upholstery			●
Plush upholstery		●	●
Electric front windows			●
Electrically heated driver's seat	●	●	●
Sunroof	Option	●	●

All models can be obtained with automatic transmission.  
 Power assisted steering is available as  
 an option on all 240 series cars.

# Specifications

## Engines

Four-cylinder, liquid-cooled with five-bearing crankshaft.

Overhead camshaft and light-alloy cylinder head.

## Cooling System

Frost-proofed and sealed. Capacity 8.3 Imp. quart. (9.5 litres).

## Electrical System

12 V/60 Ah battery. 55 A alternator.

## Fuel Tank

Capacity 13.2 Imp. galls. (60 litres). Safety location beside rear axle.

## Transmission

Manual, Diaphragm type clutch. Four-speed, fully synchronized gearbox. The Volvo 244GL and 244 GLE have overdrive operating on fourth gear.

Fully automatic transmission is also available.

## Steering Gear

Rack and pinion steering. Split steering column of safety type.

## Suspension

Front: spring strut type.

Rear: live rear axle carried in longitudinal, rubber-mounted support arms. There are also two torque rods and an anti-roll bar.

## Braking System

Triangle split dual-circuit type. Each circuit acts simultaneously on both front wheels and one rear wheel.

Special alloy brake piping. Disc brakes all round. Power assistance.

A relief valve in each circuit prevents the rear wheels from locking prematurely in emergency braking. The brake master cylinder is of the stepped bore type. The hand brake operates independently on the separate rear wheel drums.

## Instrumentation and Controls

Padded dashboard. Rheostat-controlled instrument lighting. Six-figure mileometer, tripmeter, fuel gauge and coolant temperature gauge. Warning lamps for alternator charging, oil pressure, choke, main beam, hand brake and brake failure. Tachometer. Bulb integrity sensor. Audible and optical signs for turn indicators.

Glove box light. Combined steering wheel lock and ignition switch. Centre console houses controls for electrically heated rear window, headlamp wiper/washers and 4-way hazard warning flashers; seat belt reminder; controls for heating and ventilation; cigar lighter; ashtray; space for radio.

## Other Standard Equipment

Combined lever for turn indicators, main and dipped beam and main beam flasher. Combined stalk for windscreen wipers with two speeds and intermittent wipe facility and electric windscreen washers. Halogen headlights. Automatic day-running lights. Automatic reversing lights. Boot light. Integral rear fog lights. Front head restraints. Rear 'Fasten Seat Belts' reminder. Inertia reel belts on front seats. Two inertia reel belts and one lap belt on rear seat. Heated driver's seat. 'High-impact' laminated windscreen. Padded sun visors. Day/night interior rear view mirror of safety type. Roof lining of pressed fibre-glass wool. Interior adjustable door mirror. Vanity mirror. Child-proof rear door latches. Towing points front and rear. Mud flaps. Wrap-around lights. Tinted glass (244 GL/GLE). Metallic paint (244 GL/GLE). Sun Roof (244 GL/GLE). Electric front windows (244 GLE).

<b>Turning Circle Diameter</b> Between kerbs	32' 2" (9.8 m)
<b>Boot Capacity</b> (244 DL/GL/GLE)	21.5 cu. ft. (615 dm <sup>3</sup> )
<b>Gross Laden Weight:</b>	
244 DL/GL/GLE	3925 lb. (1780 kg)
Permissible trailer weight	3307 lb. (1500 kg)

## Warranty

12 month warranty including labour and parts irrespective of mileage. We reserve the right to modify design and equipment without prior notice.

<b>Engine</b>	<b>244 DL</b>	<b>244 GL</b>	<b>244 GLE</b>
Designation	B21A	B21A	B21E
Displacement cm <sup>3</sup>	2127	2127	2127
Bore × Stroke mm	92.0 × 80.0	92.0 × 80.0	92.0 × 80.0
Max. Output hp at r/m DIN	107/5500	107/5500	123/5500
Max. Output kW at r/s DIN	79/92	79/92	90/92
Max. Torque kpm at r/m DIN	17.3/2500	17.3/2500	17.3/3500
Max. Torque Nm at r/s DIN	170/42	170/42	170/58
Compression Ratio	9.3:1	9.3:1	9.3:1
Fuel system	Single Cross-Draught Carburettor	Single Cross-Draught Carburettor	CI Fuel injection
Fuel Octane	97/98	97/98	93
<b>Wheels and Tyres</b>	<b>244 DL</b>	<b>244 GL</b>	<b>244 GLE</b>
Steel based radial ply tyres. Dimensions	175 SR 14	185/70 SR 14	185/70 SR 14
Rims	5 J-14"	5.5 J-14"	5.5 J-14"
Turn of steering wheel lock to lock	4.3	4.3	4.3

The factory reserves the right to make changes at any time, without notice, to prices, colours, materials, equipment, specifications and models and also to discontinue models.

# VOLVO